

TECHNICAL DATA

Weight:	354 kg
Base grill area:	1.130 x 465 mm
Upper grill area per level using original upper grill:	1.240 x 240 mm
Number of levels:	1 + 5
Exhaust rate:	3.500 m ³ /h
Average charcoal consumption:	18-23 kg

STANDARD EQUIPMENT

Lower Grill - 2x
 Upper Grill - 2x
 Horizontal support bars - 3 pairs
 Stainless steel skewers - 5x
 Support with a shelf

OPTIONAL EQUIPMENT

Lower Grill	565 x 465 mm
Flat Grill	280 x 465 mm
Upper Grill	620 x 240 mm
Grill Mesh	345 x 275 mm
Stainless steel skewers	



TECHNICAL DRAWINGS

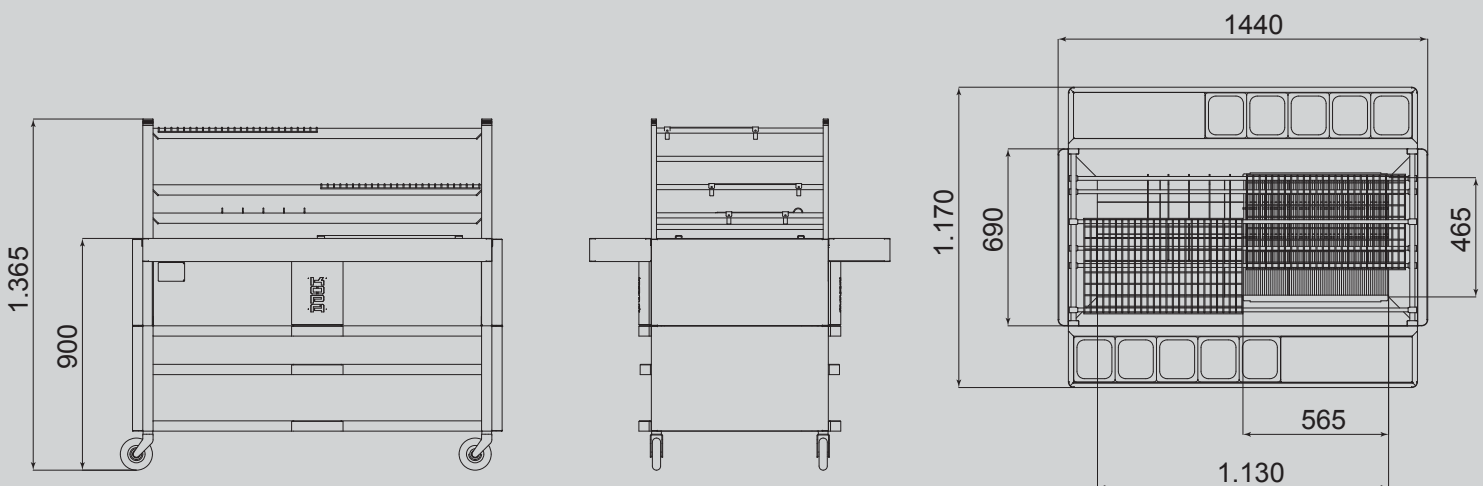

Available in these colors:



Red



Black



Brown