

TECHNICAL DATA

Weight:	805 kg
Grill rack dimensions:	2 x 930 x 735 mm
Top rack dimensions:	2 x 960 x 305 mm
Grill rack hub:	338mm (Grill rack at 25°) 390mm (Grill rack at 0°)
Grill rack inclinations:	0°; 6,25°; 12,5°; 18,75°; 25°
Fire pit material:	Refractory bricks
Exhaust rate:	5.500 m ³ /h
Average charcoal consuption:	46-50 kg

STANDARD EQUIPMENT

V-groove Rack insert - 4x
Upper Grill - 2x
Kopa poker
Kopa ash shovel
Kopa Tong

OPTIONAL EQUIPMENT

V-Groove insert:	465 x 735 mm
Round bar insert:	465 x 735 mm
Plancha insert:	465 x 735 mm
Perforated plancha insert:	465 x 735 mm



TECHNICAL DRAWINGS

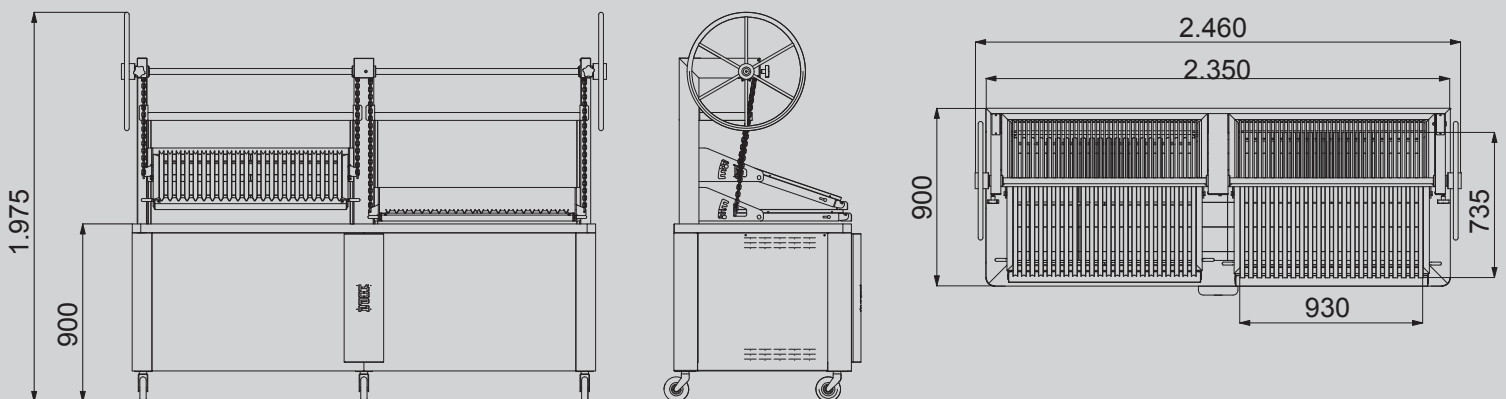

Available in these colors:



Red



Black